

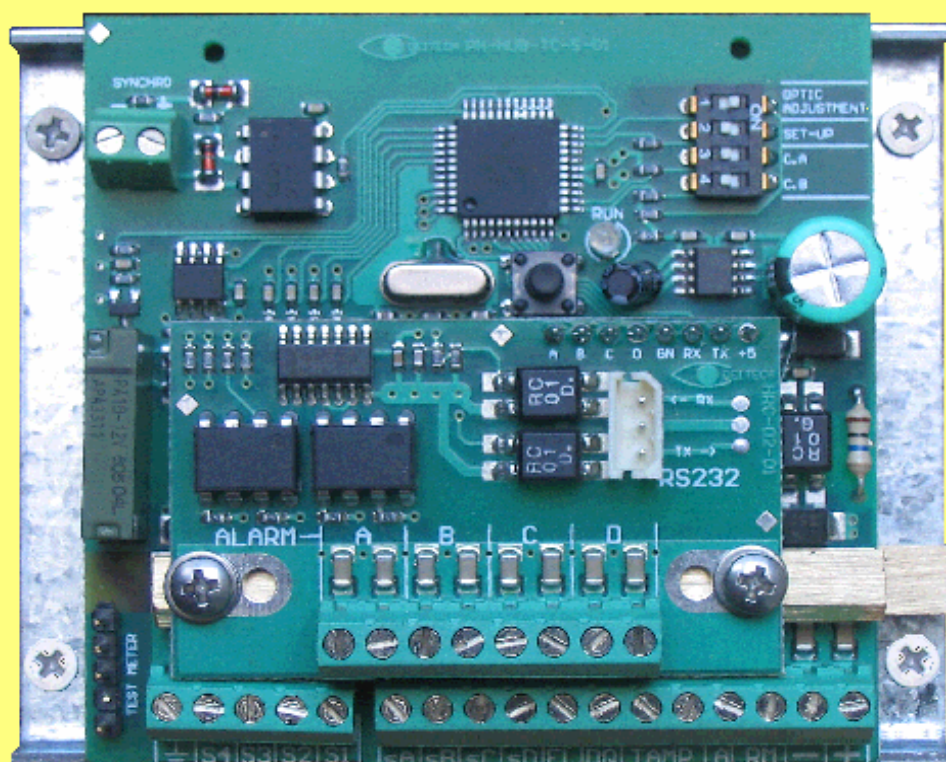

# PHOTON HUB T.C. TOTAL CONTROL

PROGRAMMABLE HUB FOR PHOTON BARRIERS



USER INSTALLATION MANUAL VERSION 1.0

## HUB TC

In order to accommodate custom installations requiring larger protected areas, it has been necessary to upgrade the standard HUB to provide total management of the functional parameters to adapt the system to the different operating possibilities that these kind of installations require.

The settings of this system (that can manage a maximum of 4 areas, 8 bidirectional beams each), would be too many to be set manually using dip-switches or jumpers on the PCB. Instead, a user-friendly SET UP program run by a PC and several software applications that allow, in addition to the set-up configuration of the system, monitoring and recording of all events (specific beams of specific areas and at the exact time an alarm is triggered), or to test the installation during the installation phase for incorrect connections.

HUB TC has a SYNCHRO input that allows more HUB TCs to be installed on the same site without reciprocal interference among barriers of different HUB TCs.

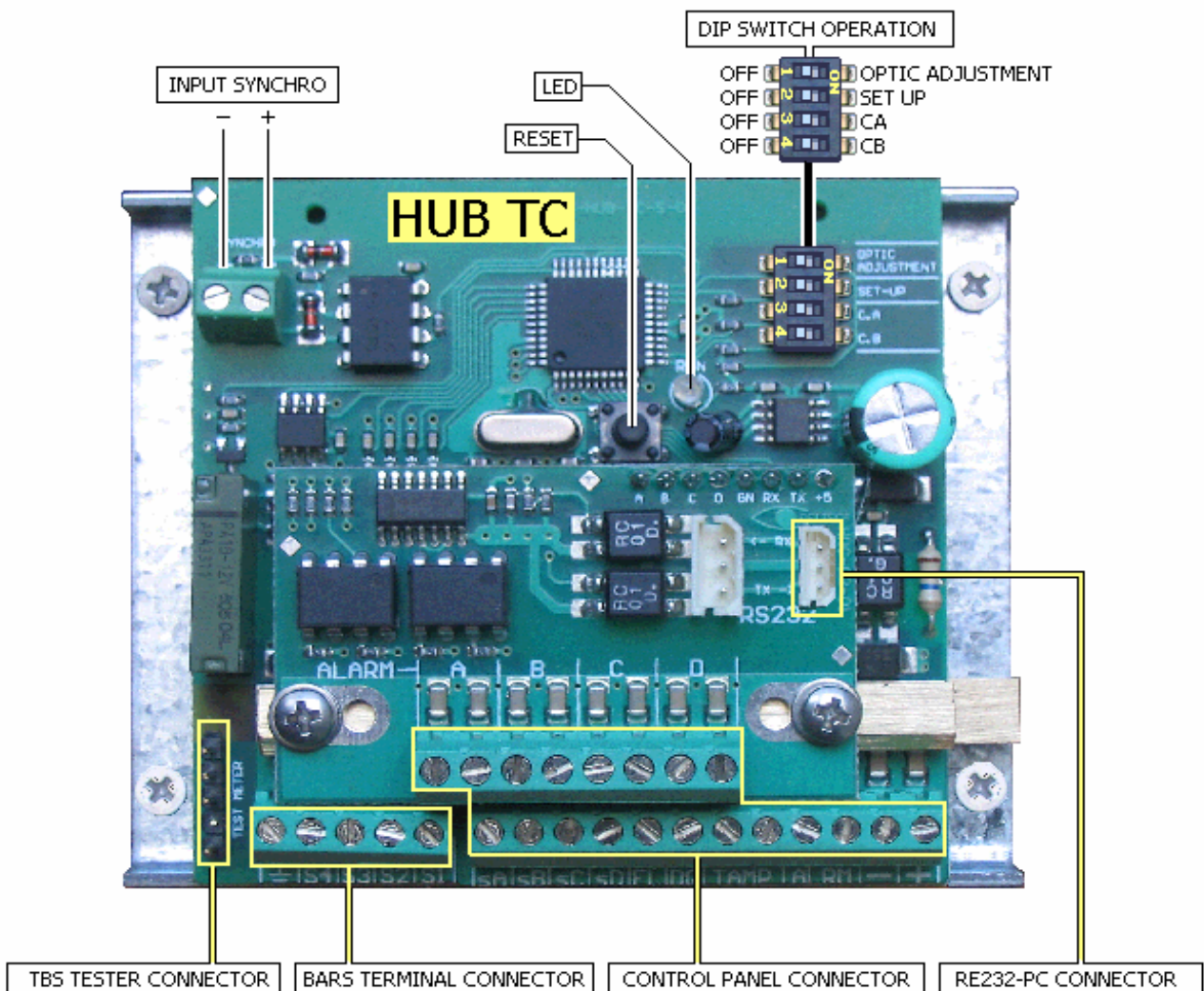

## PROGRAMMING OF THE HUB TC

PC-Windows 98 or higher

- 1 ■ Install the three programs on the CD onto your PC and place the icons on the desktop

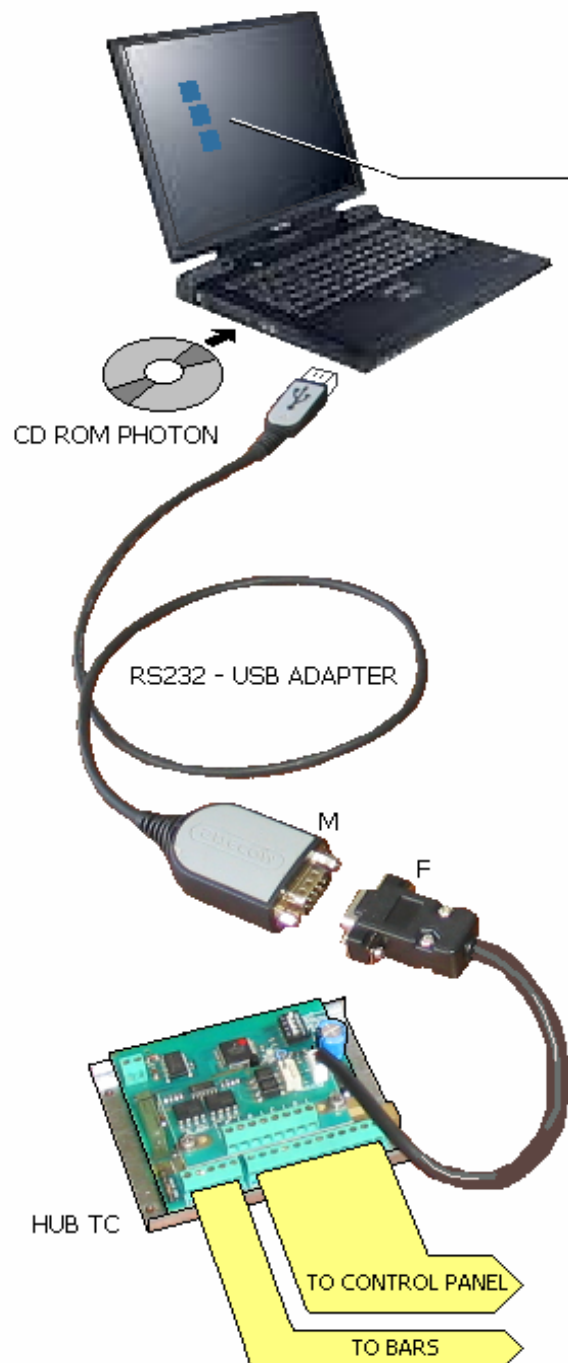

- 2 ■ Use a USB adapter for connection to the serial RS232 and connect it to the USB input of the PC
- 3 ■ Connect all the inputs/outputs to the control panel
- 4 ■ Connect the bars to the HUB TC and set all the ID addresses

Zone A, address 1 and 2  
 Zone B, address 3 and 4  
 Zone C, address 5 and 6  
 Zone D, address 7 and 8

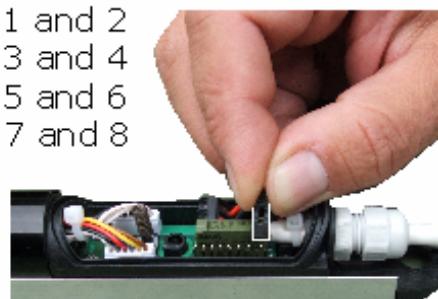

- 5 ■ Set dip switch of the HUB TC as shown in figure



- 6 ■ Connect the USB adapter to the HUB TC connector
- 7 ■ Connect power the HUB TC (9-16 VDC)
- 8 ■ LED starts blinking and then stays fixed ON, when connected

## ELECTRICAL TEST OF PROPER CONNECTIONS OF THE SYSTEM

This test allows you to check if the electrical connections between the bars and the control panel have been made properly or if there are any wiring mistakes

- Place dip-switch in the SETUP position
- Reset HUB TC (LED will blink and then light steadily when ON)
- Launch the TEST software



The following window will open.

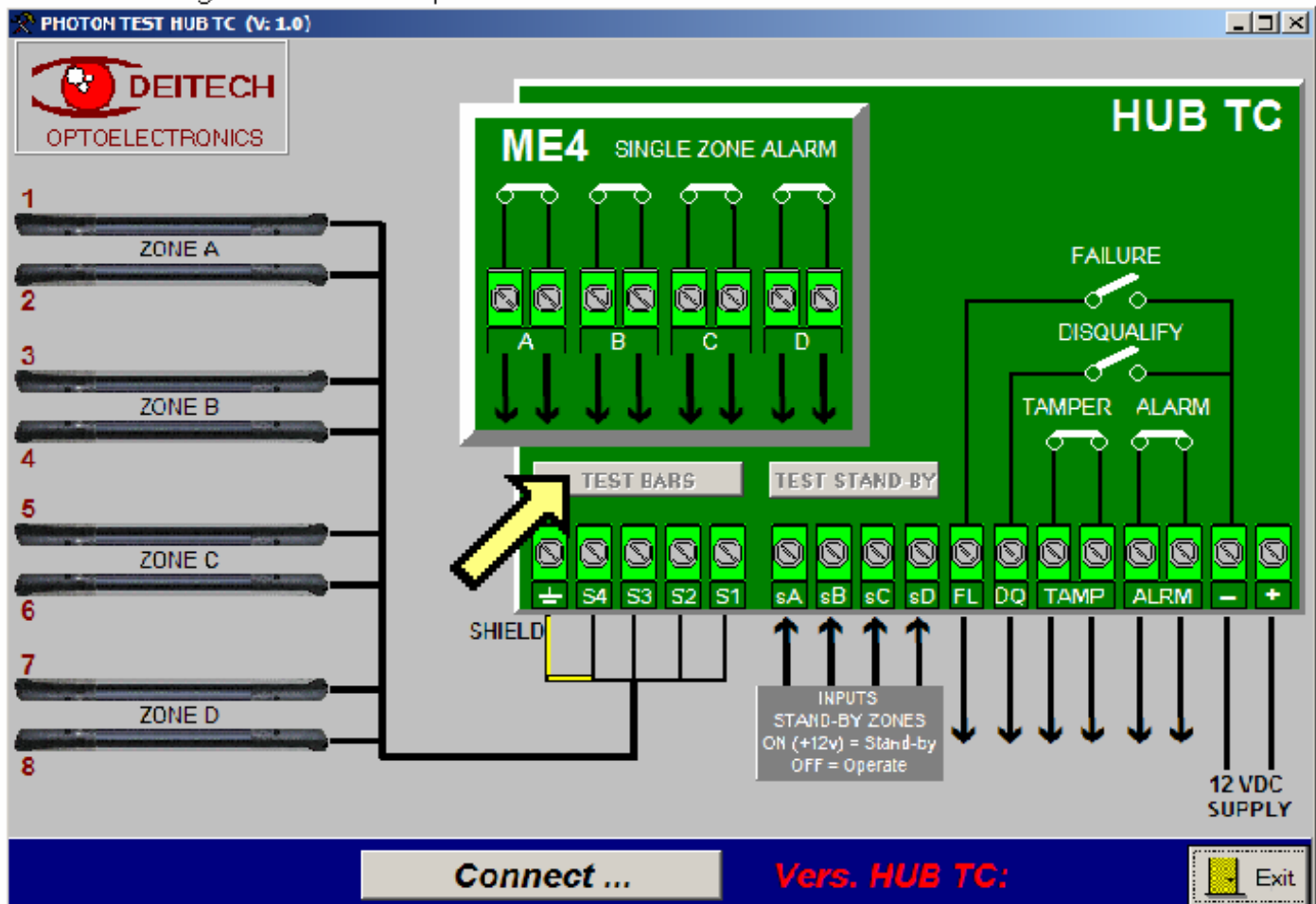

- Click CONNECT and choose the right PC port, ■ and click OK

This program will immediately check the wiring of the bars (S1, S2, S3, S4). Only the units connected properly will appear on the monitor. After the system is disconnected, to restart, click TEST BARS and another test will be initiated.

If some of the wired bars do not appear on the display it means that the bars do not answer to the test. Check the wiring and be sure each bar has the right ID address.

Warning: This test verifies only the correct electrical connections to verify the bars have been wired properly; it does not tell us if the bars of each set have the correct corresponding ID address. The bars could have been cross-connected, but because there is no duplicated ID address and there is no address overlap, there are no error messages (for example: Zone A, address 1 and 3; Zone B, address 2 and 4) even if it is not correct.

Once we received a positive response for this test, we can check the correct functioning of the output interface of the control panel by indicating with the computer mouse on the display the contact you wish to test.

- By clicking once you change the state of the contact and you can verify if the control panel received the command
- Click again and the contact will go back to the original configuration.

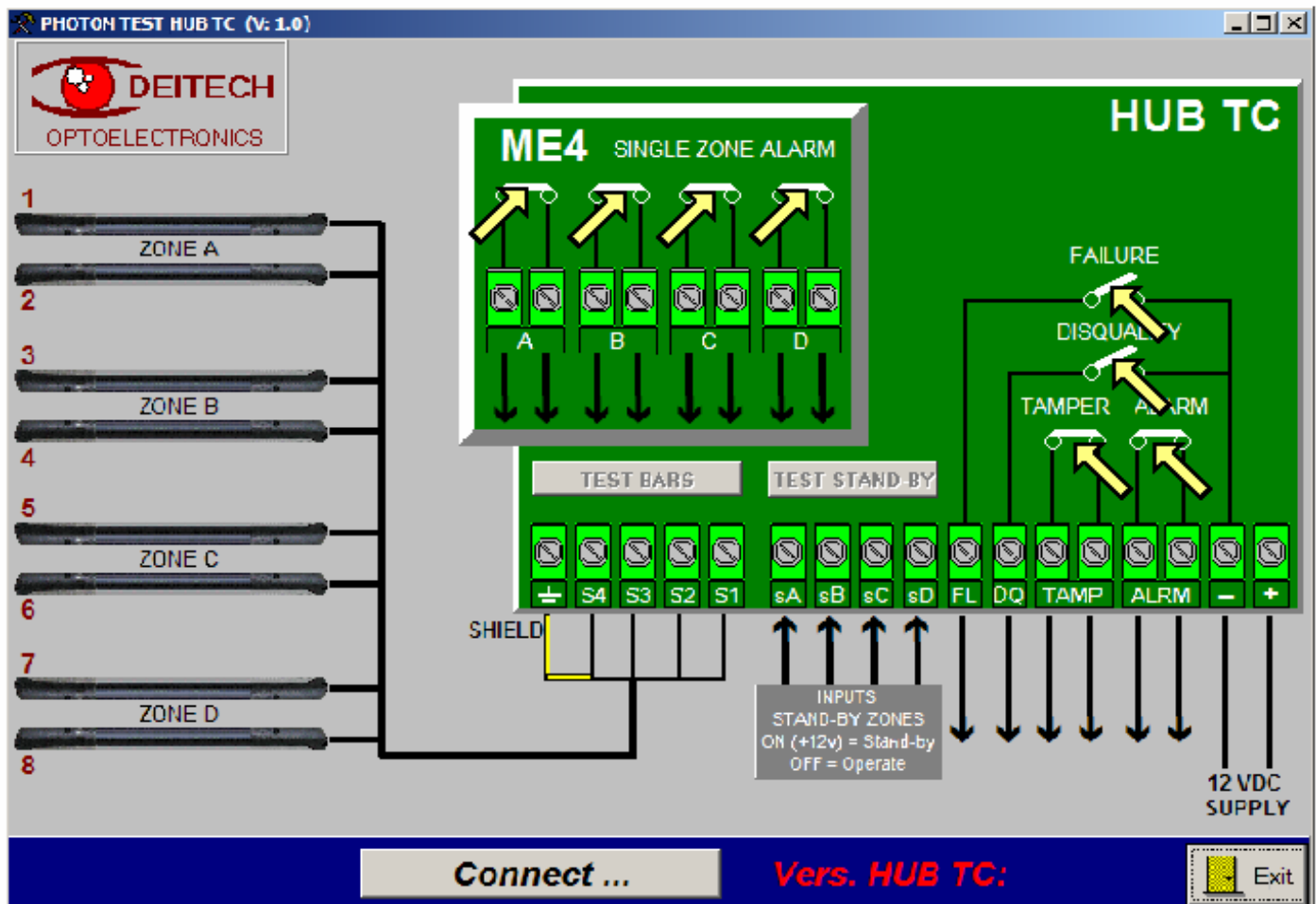

To execute the test of the STANDBY inputs (active +12V)

- Click TEST STANDBY and the current state of the terminals will be displayed.
- Click again on TEST STANDBY to verify the new state.
- Once the tests are finished, click on EXIT to quit the program.

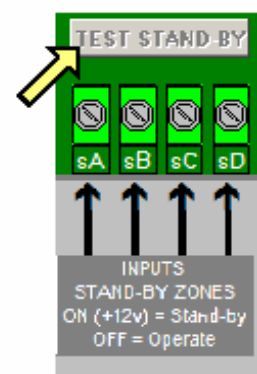

## PROGRAMMING OF THE HUB TC

- Set dip-switch as in the figure
- Enable power supply (or RESET if already supplied)
- Launch SETUP program



The following window will appear

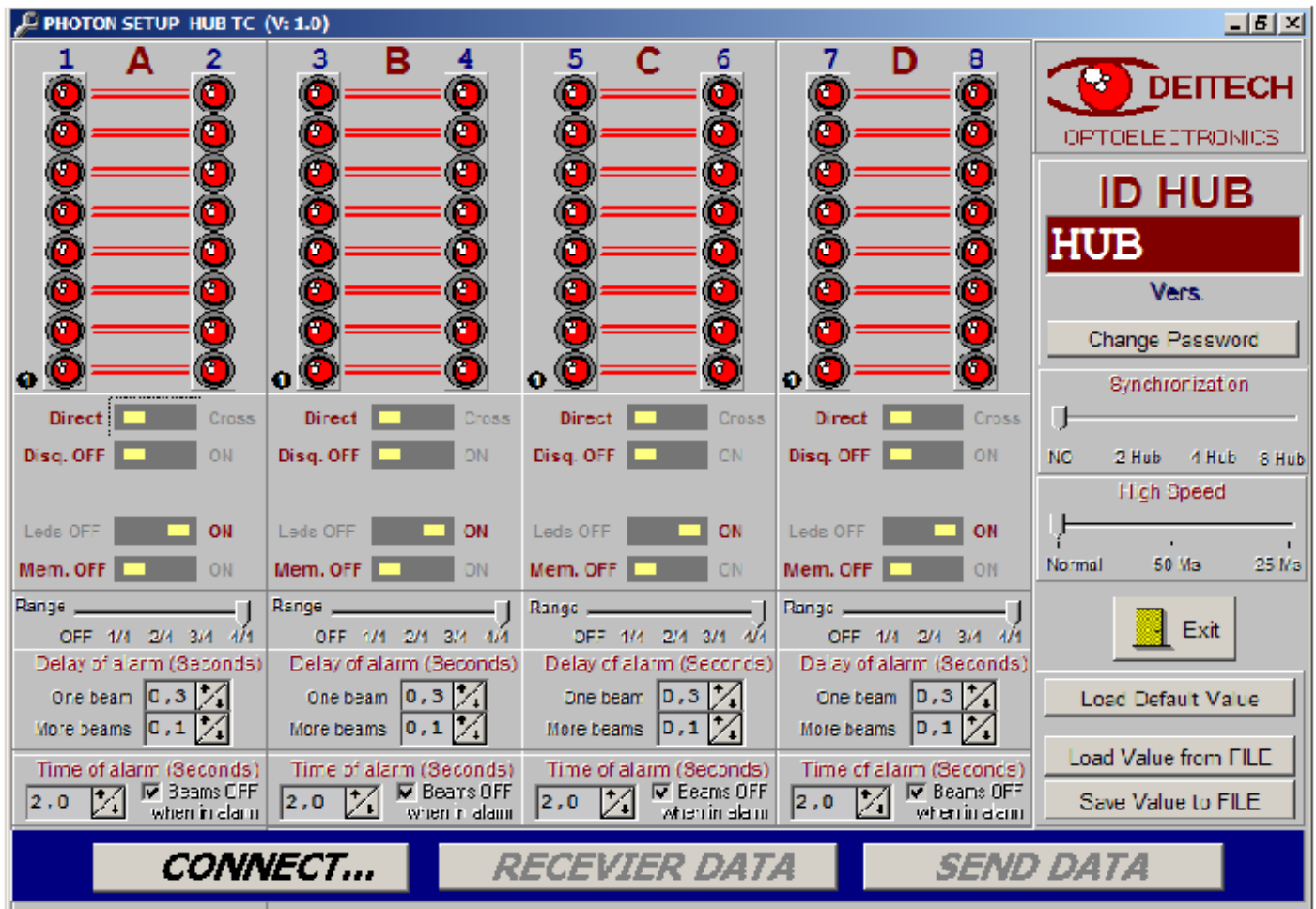

- Click CONNECT and choose the right port on the PC
- Click OK (program will load a standard SETUP)
- Click OK again.

The program is ready to transfer data



RECEIVE DATA from HUB TC to the PC, if you want to know the present configuration or you want to modify the current parameters.

SEND DATA from PC to HUB TC to transfer the SET UP configured on the display.

## SETTINGS RELATIVE TO EACH INDIVIDUAL ZONE

The diagram illustrates the configuration for a specific zone (Zone A) in a fire alarm system. It shows a layout of 8 beams arranged in two vertical bars, labeled 'Beams bar 1' and 'Beams bar 2'. The beams are numbered 1 through 8 from bottom to top. A 'Beginning of beams numbering' label points to beam 1. The zone is identified as 'Zone A'.

Below the beam layout, the following settings are shown:

- Direct beams:** **Direct** (yellow indicator) / **Cross** (grey indicator) / **crossed beams**
- Disqualification OFF:** **Disq. OFF** (yellow indicator) / **ON** (grey indicator) / **Disqualification ON**
- LED bars OFF:** **Leds OFF** (grey indicator) / **ON** (yellow indicator) / **LED bars ON**
- Alarm memory OFF:** **Mem. OFF** (yellow indicator) / **ON** (grey indicator) / **Alarm memory ON**
- Range:** A slider set to approximately 3/4, with options: OFF, 1/4, 2/4, 3/4, 4/4. **Range in respect to the maximum**
- Delay of alarm (Seconds):**
  - One beam:** 0, 3 (with up/down arrows) — **For 1 beam**
  - More beams:** 0, 1 (with up/down arrows) — **For at least 2 beams**
- Time of alarm (Seconds):** 2, 0 (with up/down arrows) — **Opening time of the relay in alarm**
- Beams OFF when in alarm** — **Beams OFF in alarm**

## DEACTIVATION OF THE BEAMS OF ONE ZONE

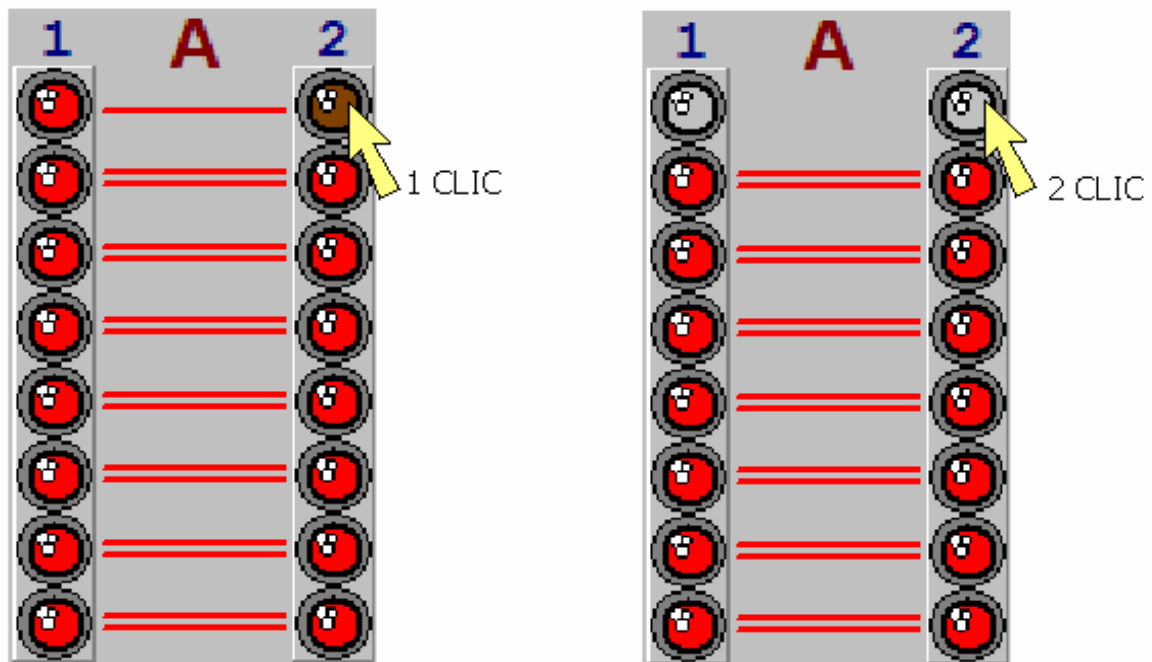

This figure is a simple representation of the bidirectional beams in which the round spheres are the infrared TXs.

It is possible to deactivate one or more beams in one or both directions:

- Place the cursor of the mouse on the TX you would like to deactivate; click once and that TX will be deactivated, clicking again will deactivate the opposite TX. In this way the beam will be completely excluded from the active function of the barrier. Click one more time and the original state will be restored.
- By deactivating all the TXs of one single bar the system will become mono-directional (one bar will transmit only and the other bar will receive only) but with a density of exploration double that of the bidirectional one.

## DIRECT OR CROSSED BEAMS AND DISQUALIFICATION

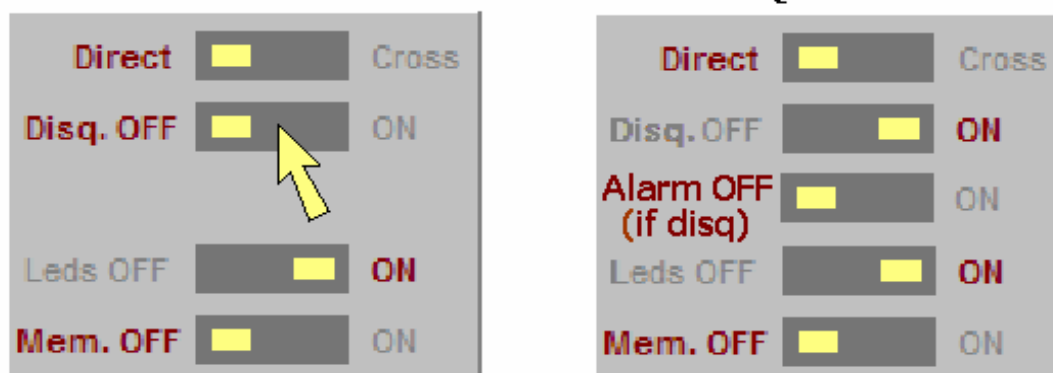

Direct or crossed beams can be chosen in the display just by clicking on them.

- If disqualification is ON, another selector will appear. You can now choose to send an alarm should disqualification of the system occur.
- The last two selectors are used to manage the signalization LEDs on the bars:  
LEDs OFF/ON  
Memory OFF/ON

## RANGE SELECTION

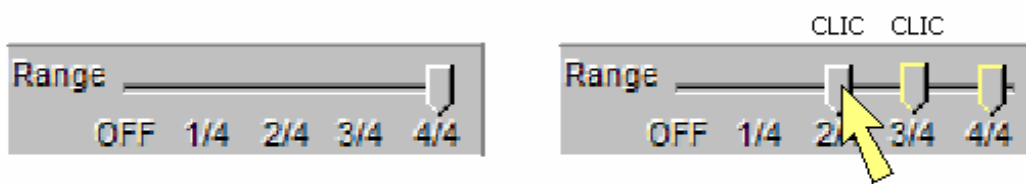

This selector manages the range of the radiant intensity emitted by the transmitters. It can be adjusted in four steps and represents the maximum range of the relative pair of bars.

|           | 1/4 | 1/2 | 3/4 | 4/4 |
|-----------|-----|-----|-----|-----|
| EB20 BARS | 6m  | 12m | 18m | 25m |
| EB40 BARS | 12m | 25m | 38m | 50m |



NOTE: For every doubling of the distance, the radiant intensity is multiplied by four

To make a change it is sufficient to move the sliding cursor on the desired value or by clicking on the sliding bar until the value is reached.



The Zones (pairs) not used may be disabled by moving the sliding cursor to the OFF position. To confirm the disabling of the relative Zone, the display will show the “Disabled” message.

## REGULATION OF THE MINIMUM INTERRUPTION TIME (in seconds)

| Delay of alarm (Seconds) |      |   |
|--------------------------|------|---|
| One beam                 | 0, 3 |  |
| More beams               | 0, 1 |  |

With this option it is possible to set-up the minimum interruption time for one beam or for more than one beam to get an alarm. These times can be varied from a minimum of 0,1 seconds up to a maximum of 2 seconds in steps of 0,1 seconds.

It must be remembered that the "one beam" time cannot be less than the "more beams" time.

| Delay of alarm (Seconds) |      |  |
|--------------------------|------|--|
| One beam                 | 0, 3 |   |
| More beams               | 0, 1 |  |

Click to increase  
Click to decrease

## REGULATION OF THE OPENING TIME OF THE RELAY IN ALARM

| Time of alarm (Seconds)                                     |   |
|---|---|
| 2, 0  |  |
| <input checked="" type="checkbox"/> Beams OFF when in alarm |   |

energy saving

This regulation manages the temporization of the normally closed alarm relay. The opening of the contact in alarm stage can be adjusted from a minimum of 0,2 seconds up to a maximum of 10 seconds with steps of 0,2 seconds

There is also an option to enable energy saving:

When a Zone is in alarm condition, the system will turn off the relative infrared transmitters for the alarm duration.

### COMMON SETTINGS FOR ANY ZONE

The screenshot displays the configuration interface for the DEITECH OPTOELECTRONICS ID HUB HUB Vers. 1. The interface is organized into several sections:

- Header:** DEITECH OPTOELECTRONICS logo.
- Title:** ID HUB HUB (with a red bar behind the word HUB) and Vers. 1.
- Change Password:** A button labeled "Change Password" with an annotation: "Change of access password (only if used)".
- Synchronization:** A slider control labeled "Synchronization" with an annotation: "Synchronization Properties (only for multiple HUBs)". The slider has tick marks for "NO", "2 Hub", "4 Hub", and "8 Hub".
- High Speed:** A slider control labeled "High Speed" with an annotation: "Alarm Triggering in HIGH SPEED mode". The slider has tick marks for "Normal", "50 Ms", and "25 Ms".
- Exit:** A button with a yellow icon and the text "Exit" with an annotation: "Exit from set-up program".
- File Operations:** Three buttons: "Load Default Value", "Load Value from FILE", and "Save Value to FILE". These three buttons are grouped by a bracket with an annotation: "Local Load and Save of the set-up for following applications".

## HUB IDENTIFICATION NAME

In this field it is possible to assign an 8 character Identifier Name for any HUB. You can easily build a database with all the installations included. Every HUB can have a personalized name in order to distinguish one Hub from the others.

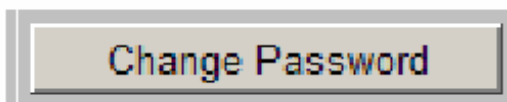

## PASSWORD CHANGE

You can insert a 6 character password for access to the HUB set-up. Once inserted and confirmed, the password will be requested every time you try to connect to the Hub set-up. If you forget the password, you will not be able to access the HUB set-up. In this case, you have to reset the hub to the factory default, using the following steps:

With the HUB powered ON, turn on all the dips, as shown in figure. Press the reset button and the previous set-up will be cancelled.

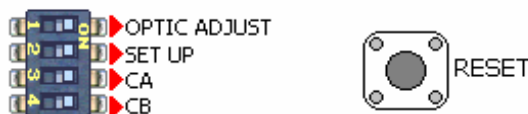

Move the CA and CB dips to OFF and re-press the reset button. Now the HUB is programmed without any password and it is ready to be re-programmed.

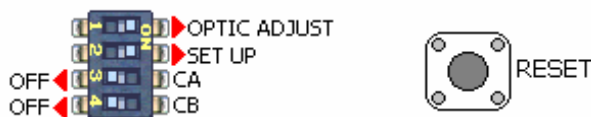

**WARNING:** If the HUB is connected to an external security panel, remember to disable the alarm inputs of the panel connected to the HUB.

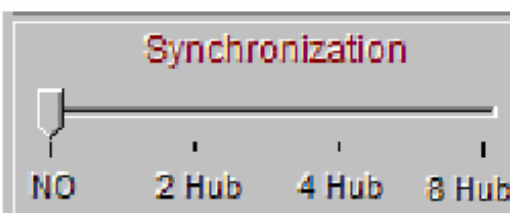

## EXTERNAL SYNCRONIZATION PROPERTIES

ONLY FOR MULTIPLE HUBs SYSTEMS  
WHERE IT IS NEEDED

Set the same setting of the synchronizer board SYNC (X2 X4 X8). See SYNC manual for more information.  
Set the option to the NO position for HUBs not to be synchronized.

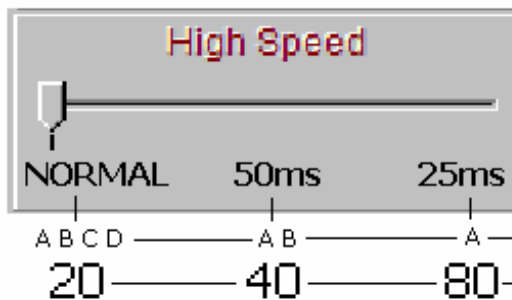

## ALARM TRIGGERING IN "HIGH SPEED" MODE

In any particular application, it can be useful to program a quicker detection time of the barrier. That means there is the need to detect moving bodies that interrupt the protected barrier for less than 100 milliseconds. Should this be the case, it is possible to program that parameter down to 50 or 25 milliseconds. In the first case the number of Zones (pairs) that can be connected to the HUB is reduced to 2 (only A and B) and the frequency of beams checking twice its value. In the second case only Zone A can be connected with a quadruple checking frequency

## PROGRAMMING UPLOAD TO THE HUB



Once the settings of the program have been completed, you have to upload them to the HUB by clicking the "SEND DATA" button. Once the upload is correctly completed, the software will show a confirming message.



If you want to change some parameters of a previously programmed HUB, click on "RECEIVE DATA". The software will download the set-up configuration from the HUB. Once the parameters are changed, click on "SEND DATA" to upload the changed settings to the HUB.

## SAVING A SET-UP ON A PC OR LOADING A SET-UP FROM A PC

With these commands you can:

|                      |  |
|----------------------|--|
| Load Default Value   | load a factory default set-up,                               |
| Load Value from FILE | load a set-up from a file in your archive folder,            |
| Save Value to FILE   | save the visualized set-up on a file in your archive folder. |

CLICK "EXIT" BUTTON TO EXIT FROM SOFTWARE



## STARTING AND TESTING OF THE SYSTEM

Once the set-up program has been up-loaded to the HUB, turn OFF the SET-UP dip switch and press the RESET button.

The system will restart in the testing mode. You can adjust the beams using the field tester (TBS).

The continuous blinking LED on the HUB means the mode is working correctly.

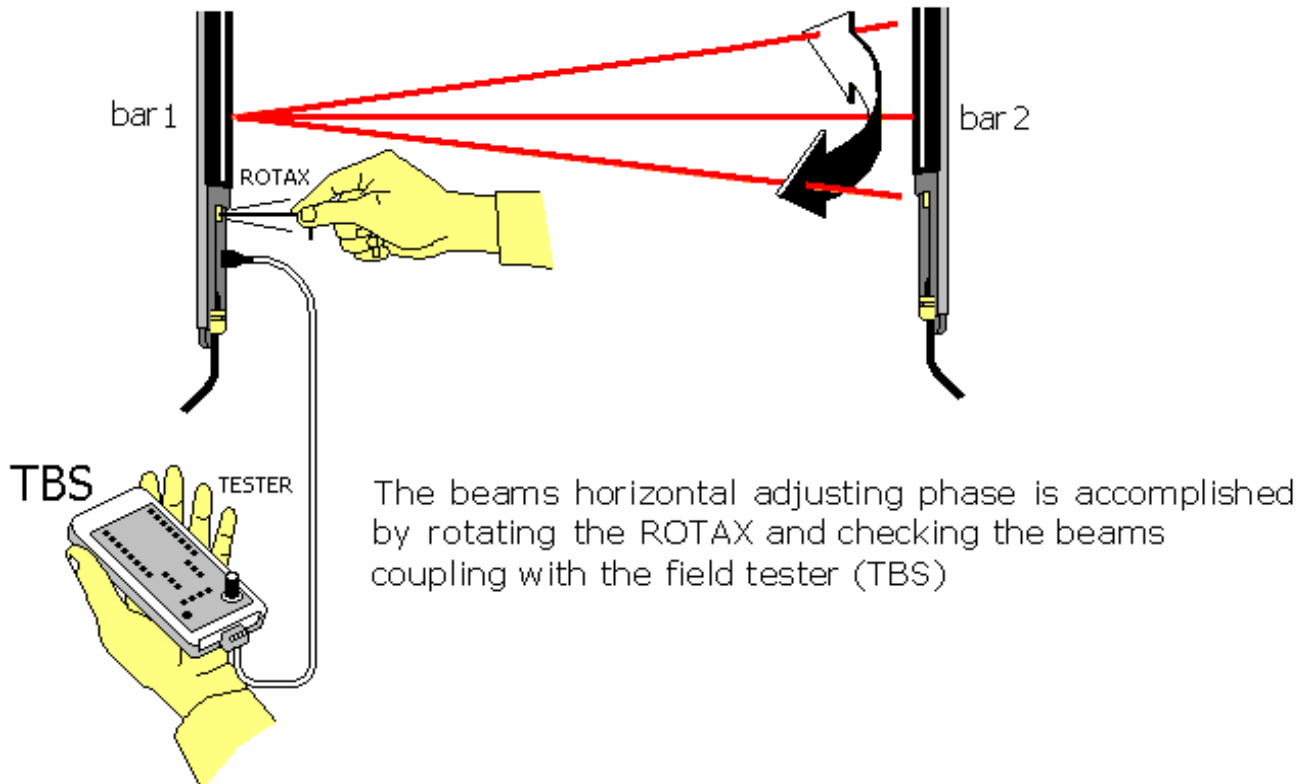
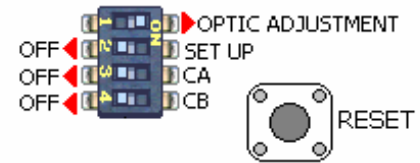

The beams horizontal adjusting phase is accomplished by rotating the ROTAX and checking the beams coupling with the field tester (TBS)

If the system does not start working properly, the HUB will advise the user of the problem with different frequency blinking of the LED. For example:

2 blinks – Bars with different ranges coupled together (mix) [EB20 bar coupled with EB40 bar]

3 blinks – At least one bar with incorrect ID address

4 blinks – At least one bar not responding

5 blinks – At least one bar with old release settings is not compatible (only when working with a synchronizer)

Once the test has been completed successfully, turn OFF all the dip switches and press the reset button. The system will restart in the operating mode.

The continuous blinking LED on the HUB means the mode is working correctly.

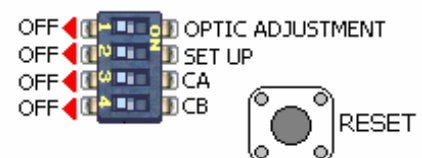

## MONITOR SOFTWARE

Connect the active HUB to the PC and start the MONITOR software. It will appear in the following window

Click on the button **RICEZIONE DATI**, (data receive) then select the serial port number connected to the HUB and check the box **MEMORIZZA DATI** (data storage) if you want to store the acquisitions on a local file. Then click OK.



If a red warning "NO DATA" appears, exit from the software and start again or press the reset button on the HUB.

Acoustic alert for beams status change

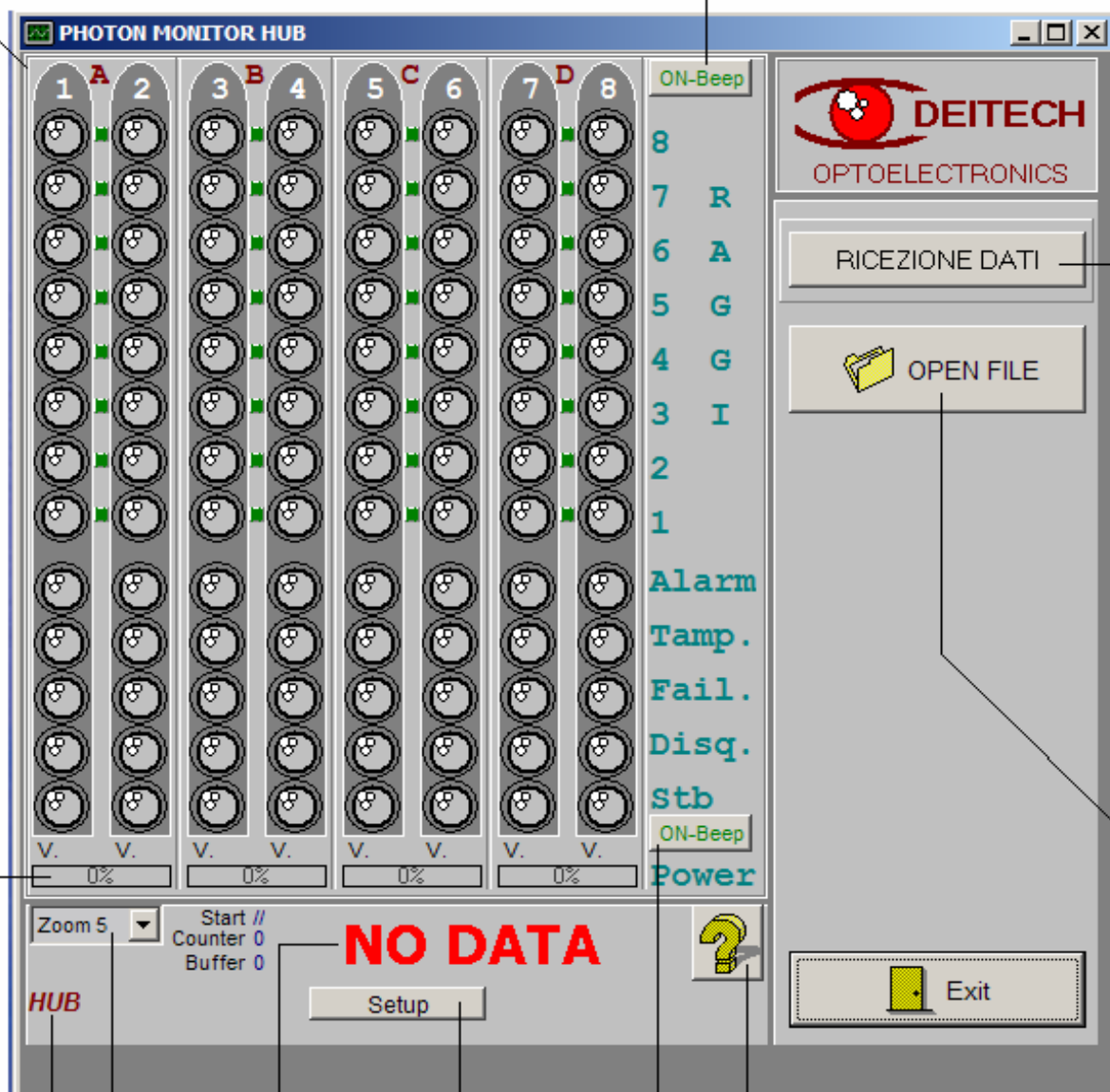

HUB name

Range selected

Window's dimension on screen

No connection warning advice

Show the set-up parameters of the HUB

Acoustic alert for signalling status change

Help

Chronologic events log

## TECHNICAL FEATURES

Type: Electronic PCB not-protected from weather events.  
To be used in an indoor environment

- **STAND-BY INPUTS** (PARTITION OF THE 4 ZONES)  
CONTACTS FREE FROM VOLTAGE OR CONNECTED TO GND = ENABLED ZONE  
CONTACTS CONNECTED TO POSITIVE SUPPLY VOLTAGE = DISABLED ZONE
- **ISOLATED OUTPUT (OPTO M.O.S. RELAYS ) FOR ALARM AND TAMPER**  
CLOSED CONTACT = SYSTEM "ARMED" (CONTACT RESISTANCE 20 OHM)  
OPEN CONTACT = SYSTEM IN "ALARM" OR "TAMPER" (CONTACT RESISTANCE > 10 MOHM)
- **OUTPUT OPEN COLLECTOR TO GROUND FOR FAILURE AND DISQUALIFICATION**  
OPEN = SYSTEM "ARMED"  
CLOSE TO GND = ACTIVE SIGNALLING (MAX 50mA 12V)
- **POWER SUPPLY** = 9-16 VDC 900 mA MAX (WITH 8 EB200 BARS CONNECTED)
- **SIGNALLING** = 1 LED
- **RESET** = MANUAL COMMAND WITH BUTTON ON PCB (ENABLES THE DIP-SWITCHES TO BE CHANGED)
- **TO BE MOUNTED IN CONTROL PANEL CASE OR PROTECTED CASE**

DICHIARAZIONE DI CONFORMITA'  
DECLARATION OF CONFORMITY



IL PRODUTTORE  
THE MANUFACTURER DEITECH S.R.L. VIA CHAMBERY 79/10 TORINO -ITALY  
DICHIARA CHE QUESTI PRODOTTI  
DECLARES THAT THESE PRODUCTS

### PH-HUB TC

SONO CONFORMI ALLE SEGUENTI DIRETTIVE EUROPEE  
CONFORMS WITH THE FOLLOWING EUROPEAN DIRECTIVES

COMPATIBILITA' ELETTROMAGNETICA  
ELECTROMAGNETIC COMPATIBILITY

**EMC 89/336/CEE**  
EN 61000-6-1  
EN 50130-4

SICUREZZA ELETTRICA  
ELECTRIC SAFETY

**LVD 73/23/CEE**  
EN 60950-1

TORINO - ITALY - 24-4-2006 VITO DISABATO

DIRETTORE GENERALE  
GENERAL MANAGER



VIA CHAMBERY 79/10 TORINO ITALY  
TEL 011 704 867 - FAX 011 701 254  
www.deitech.it info@deitech.it